

AVOLT

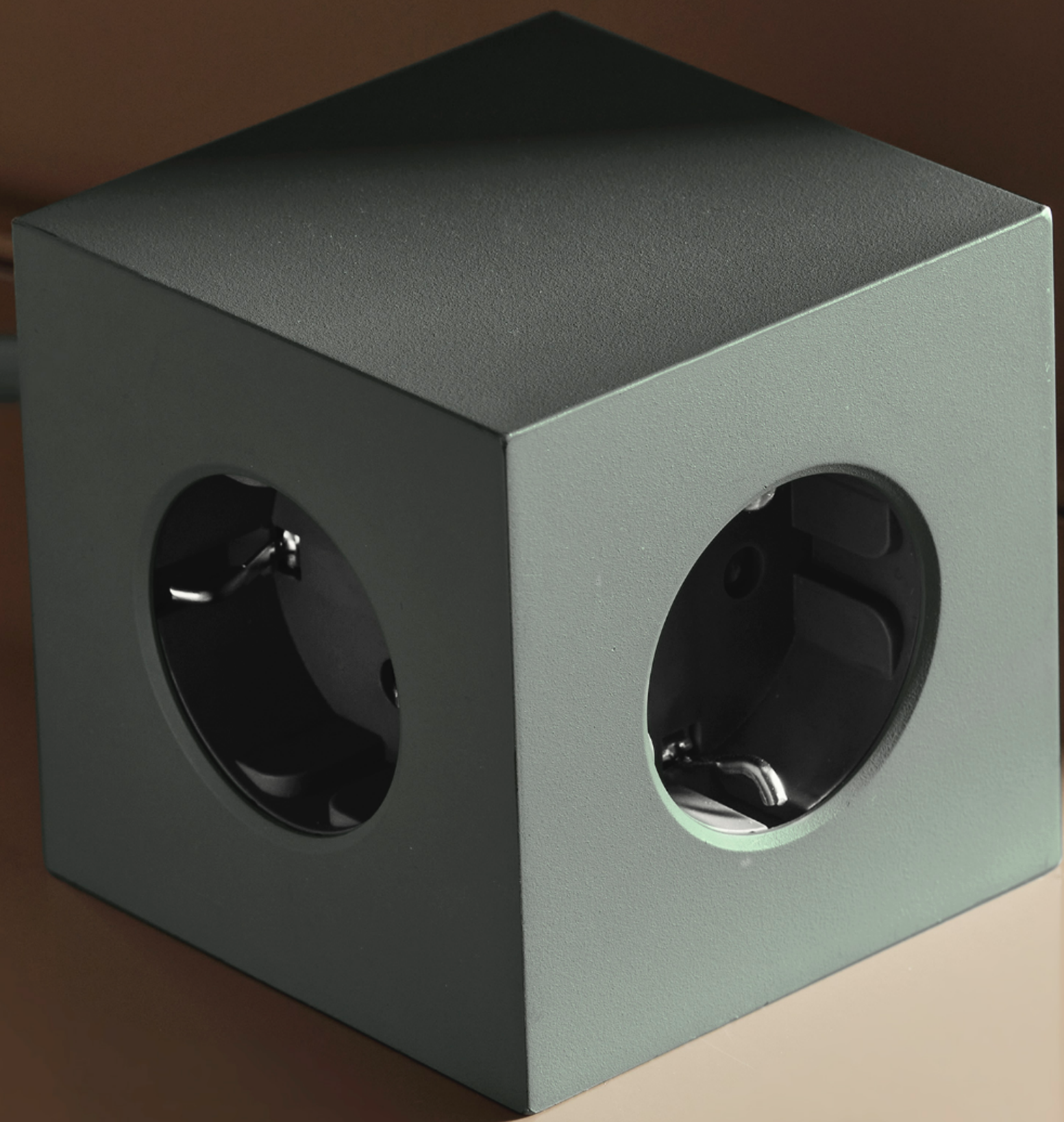



## About us.

Avolt is a Swedish based design studio that develops, designs and markets objects that extend electricity to devices, deploying Scandinavian design for homes, offices, retail environments and public spaces.



reddot award 2019  
winner



SVENSKA  
DESIGN  
PRISET



Square 1 - Old Pink, Limited Edition





Square 1 - Stockholm Black

## **Our vision.**

Impact and empower people's life by designing beautiful, timeless and sustainable objects that connects your devices to electricity, without compromising architecture and interior design.



## **The square.**

The mother of all shapes.

All sides equal. All right angles.

Making all opposite sides parallel,  
as a mere consequence of it's  
geometrical perfection.

Steady. Solid. Functional.

Trustworthy. Something to build  
great things with.

The square loves your ideas.

It is yours to play.

For designers. Architects. Inventors  
and entrepreneurs.

And for you.

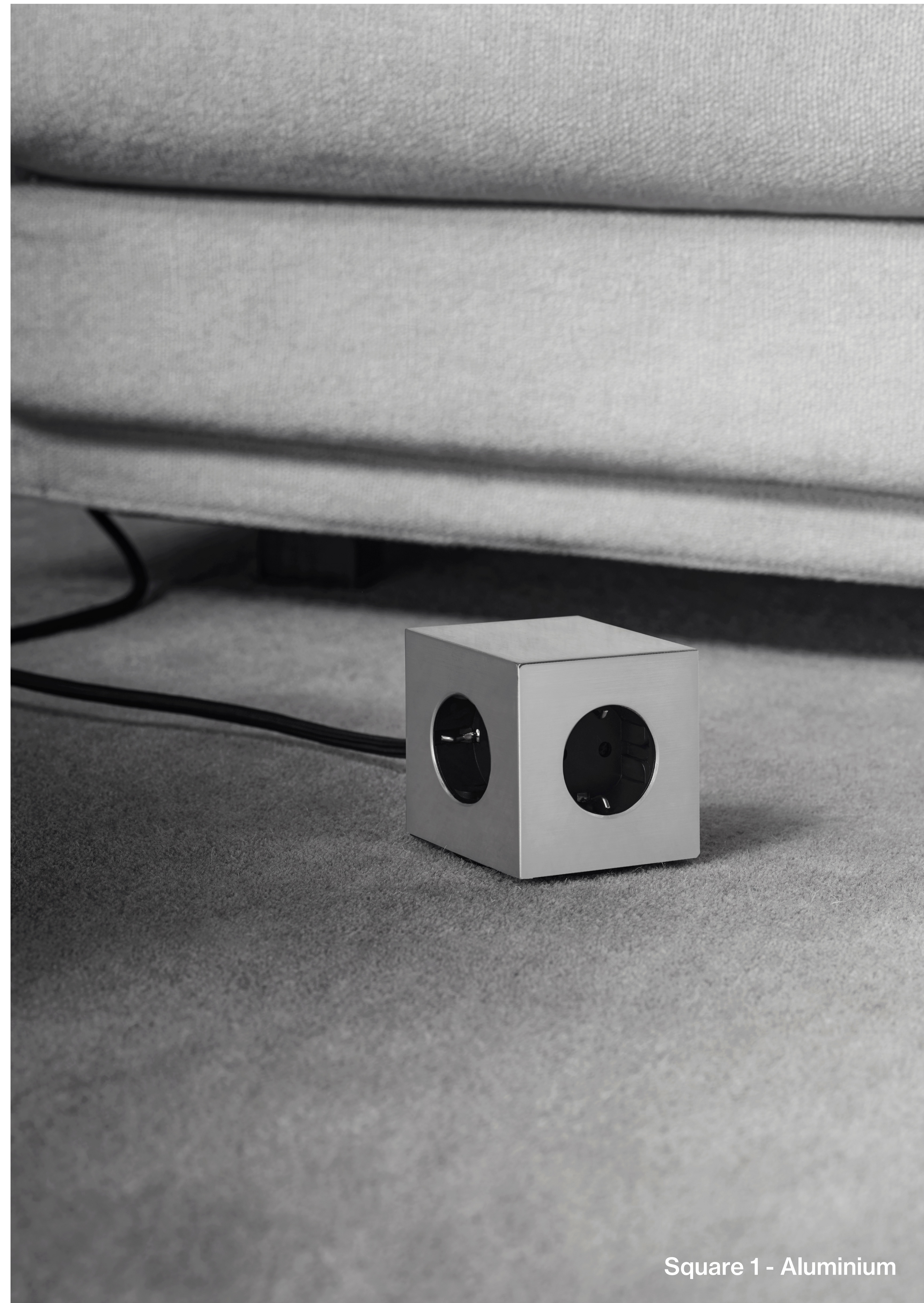

Square 1 - Aluminium





Square 1 - Rusty Red

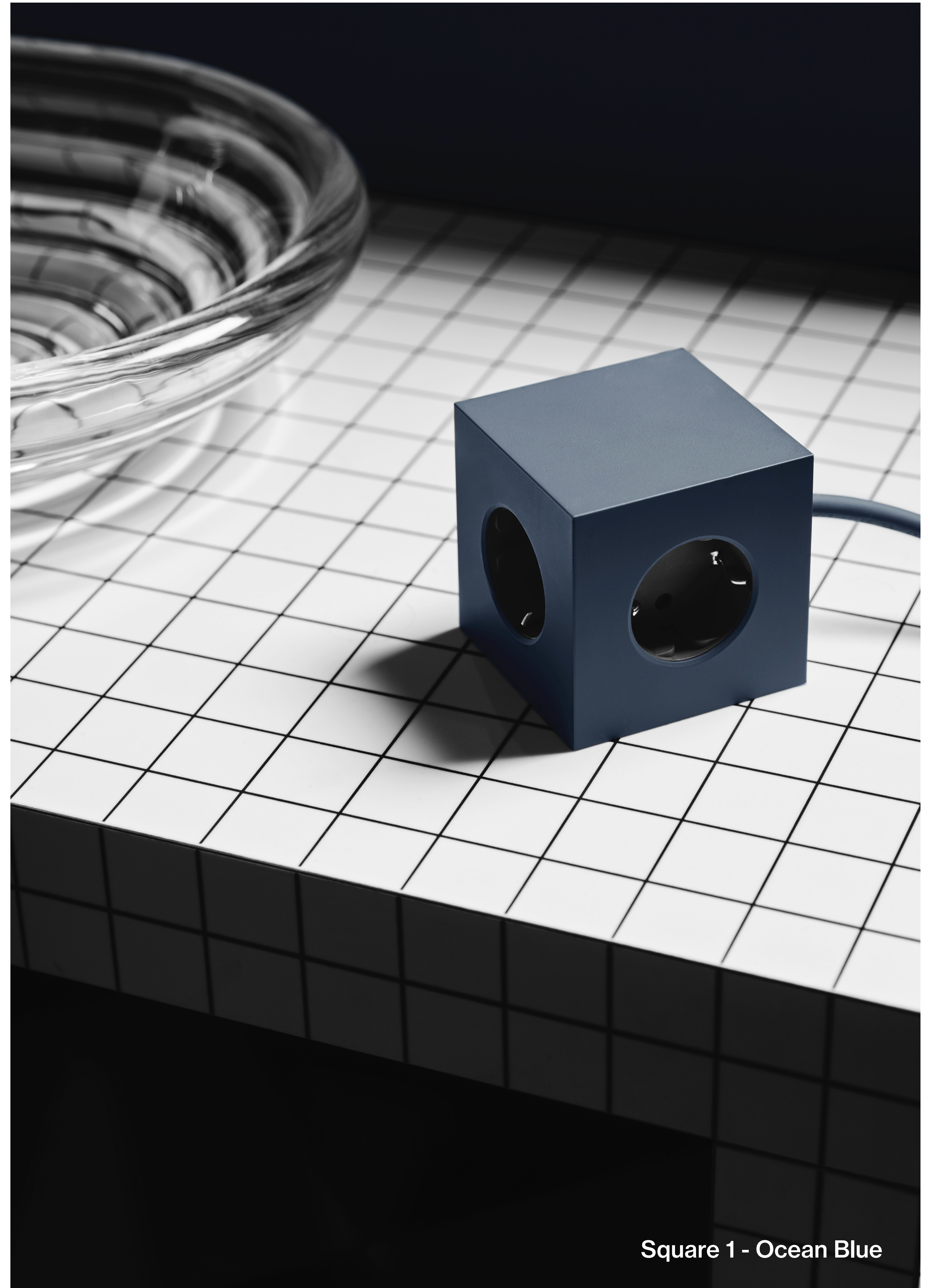

Square 1 - Ocean Blue



**“Architects always plan for built in sockets, but once people start to use a space, extra sockets are always needed”**

- Johan Runströmer, Founder of Avolt

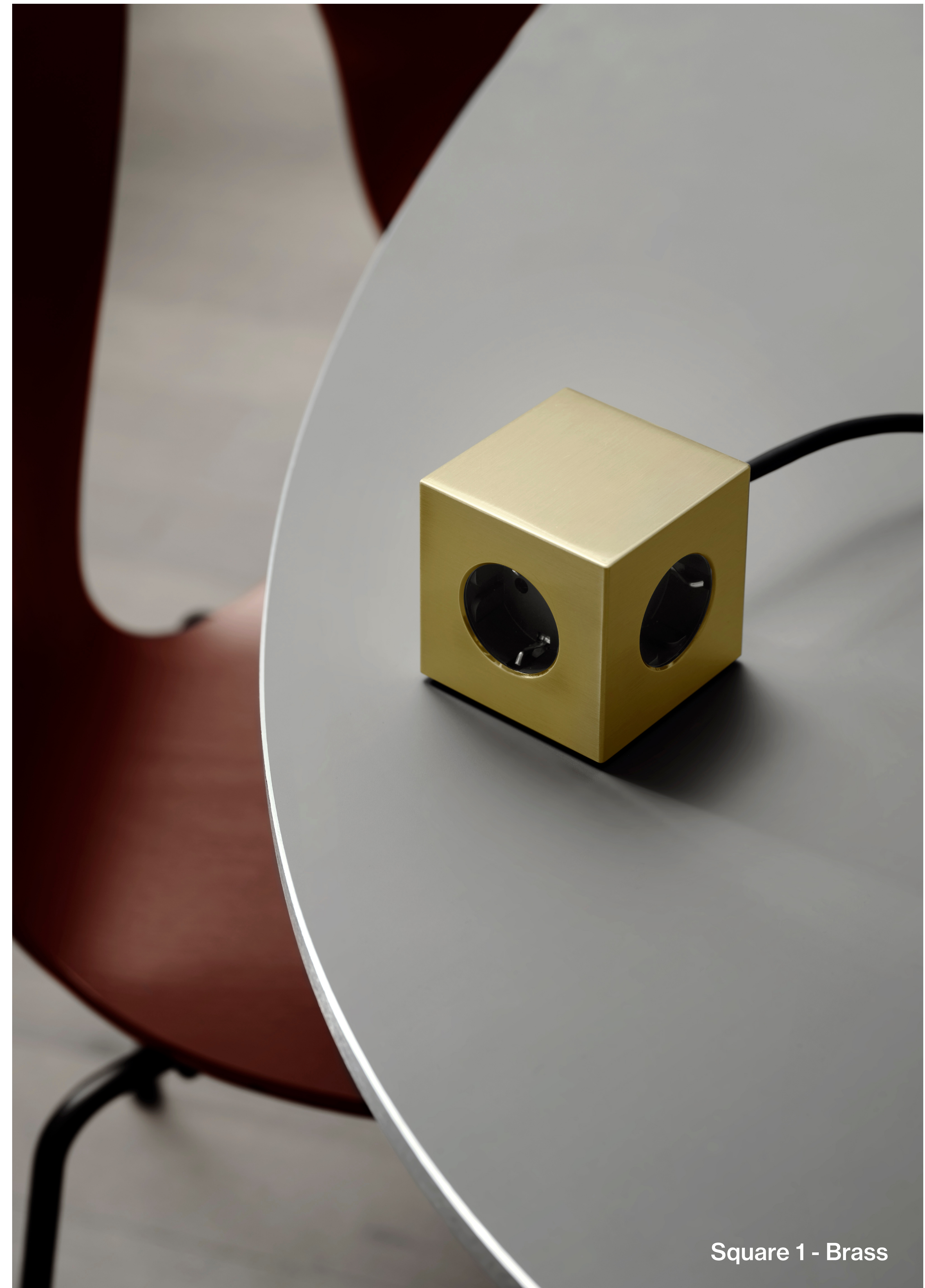

Square 1 - Brass



Square 1 - New colours

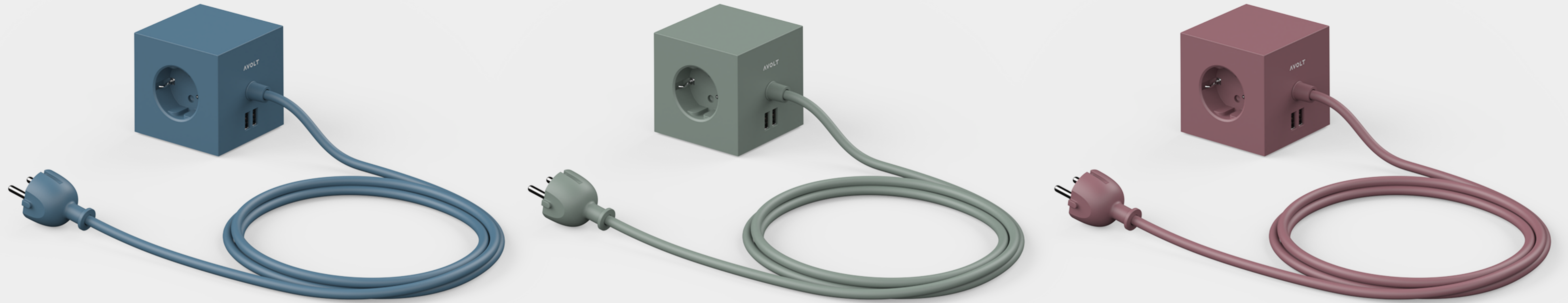

Square 1 - Original colours

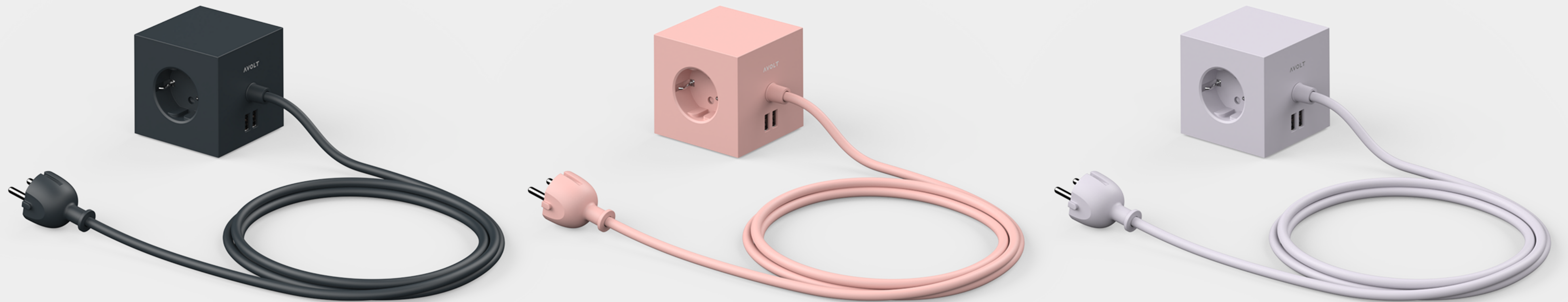



**Brass**





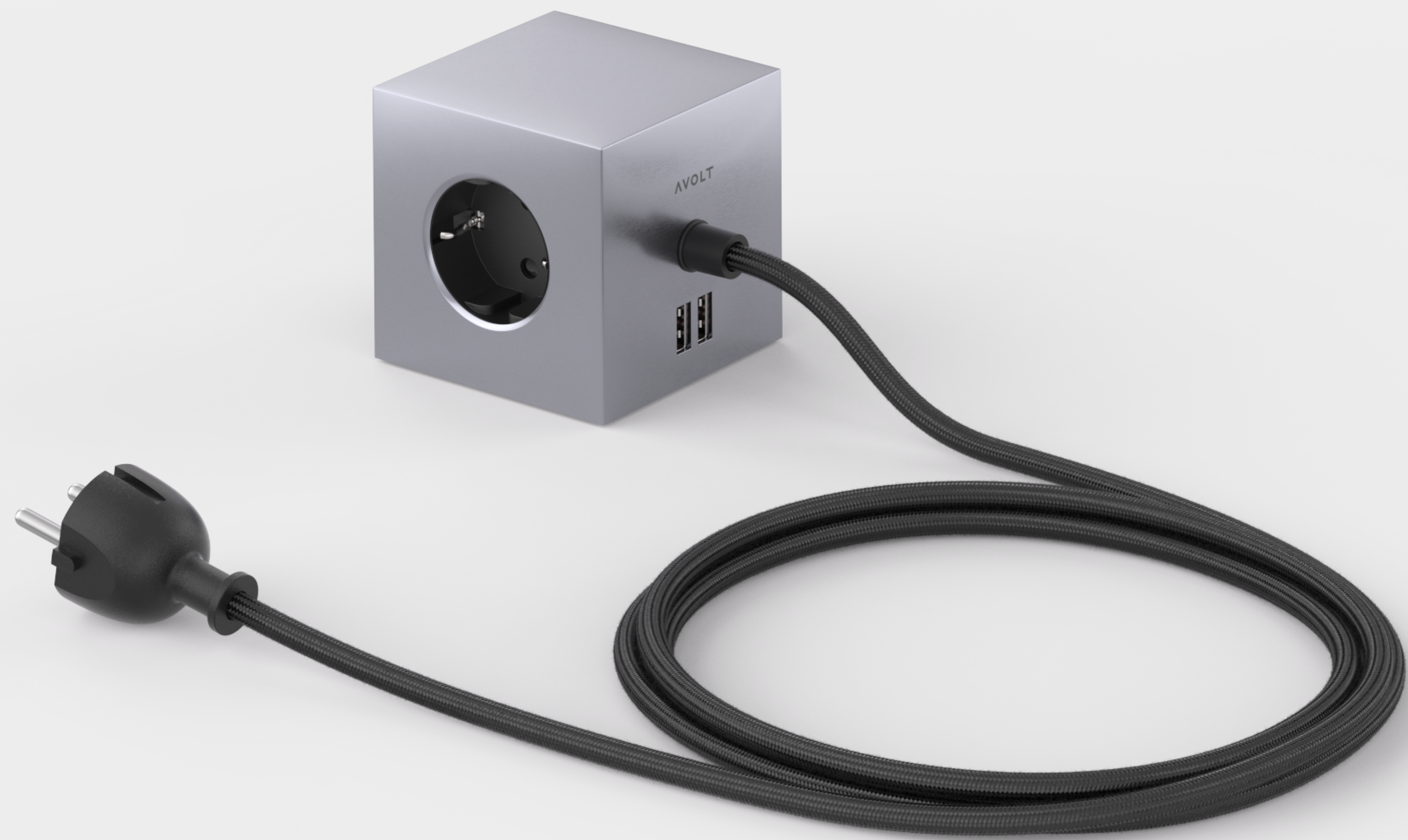





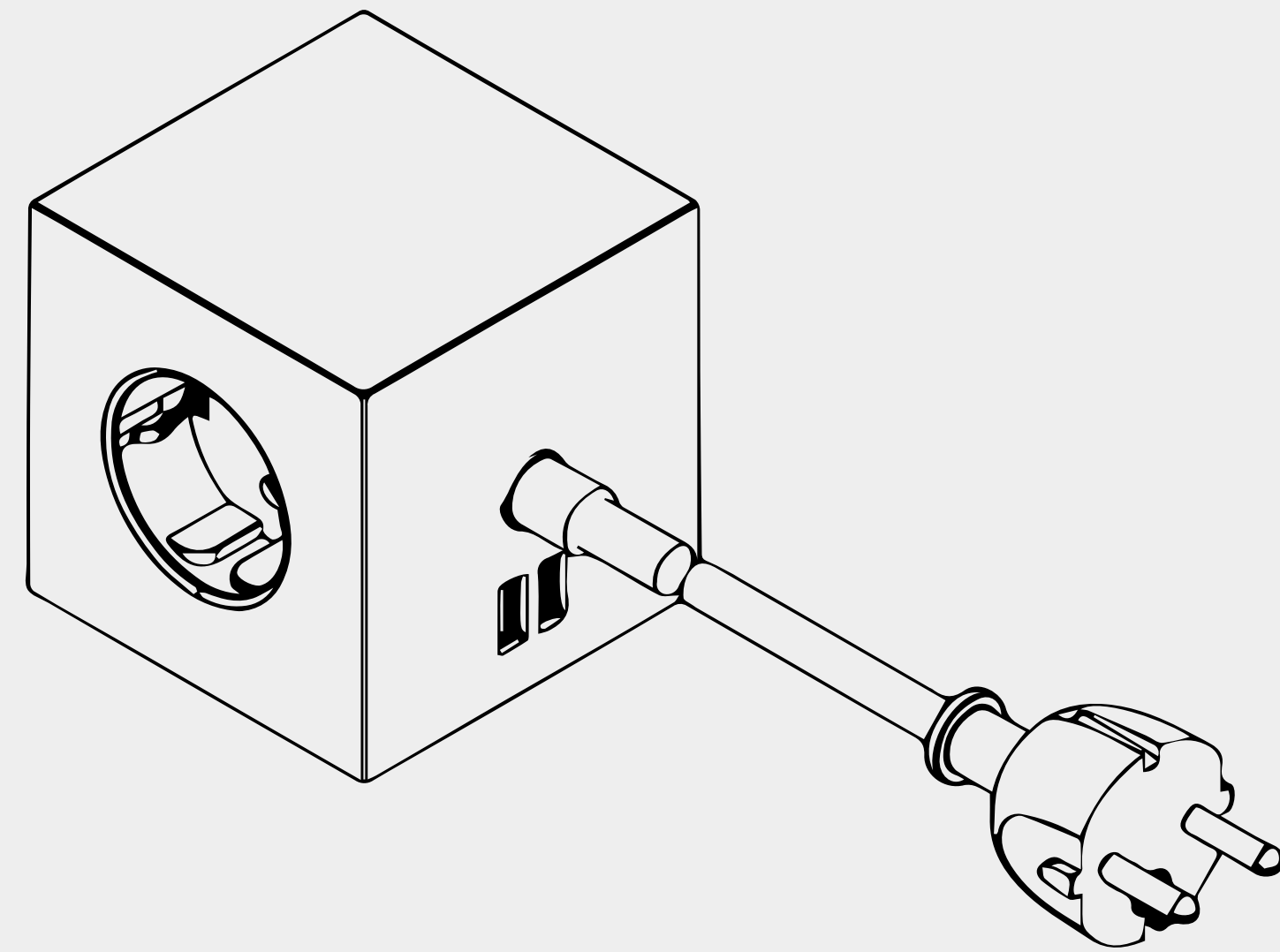

**Aluminium**



# Specifications



|  |  |   |
|--|--|---|
|  | Model:<br><p style="text-align: center;"><b>Square 1</b></p> | By:<br><p style="text-align: center;"><b>AVOLT</b></p>  |
|  | Designed and engineered in Sweden.<br>Assembled in P.R.C.    | Designers:<br>J. Runströmer<br>V. Lundberg  |
|  | Product name:  | Square 1 USB  |
|  | Material:  | Zinc-Aluminium Alloy, Plastic (+20% recycled materials)   |
|  | Cable length / plug:   | 1.8m (rubber finish) / F-type schuko  |
|  | Dimensions:  | 7.6 x 7.6 x 7.6 cm  |
|  | Socket:  | 3x Type F - 16A, 100-240V - 50/60 HZ, MAX 3680W   |
|  | USB:   | 2x USB Type A, Total Output - 5VDC, Max 3,1A<br>Single Output 5VDC, Max 2,1A  |
|  | Product weight:  | 400g for color versions, 770g for metal alloy versions  |
|  | Features:  | The bottom of the product is magnetic. It can be attached on any vertical or horizontal surface. An extra metal plate with 3M tape is included in the package. This product's materials have excellent electrical and thermal insulation characteristics. The sockets are child proof and equipped with a protective shutter.   |
|  | Color Options:   | Stockholm Black, Gotland Gray, Old Pink, Rusty Red, Ocean Blue, Oak Green, Aluminium and Brass.   |
|  | Certifications:  |      |



# Sqaure 2



Sqaure 2 - Wall mount in Stockholm Black



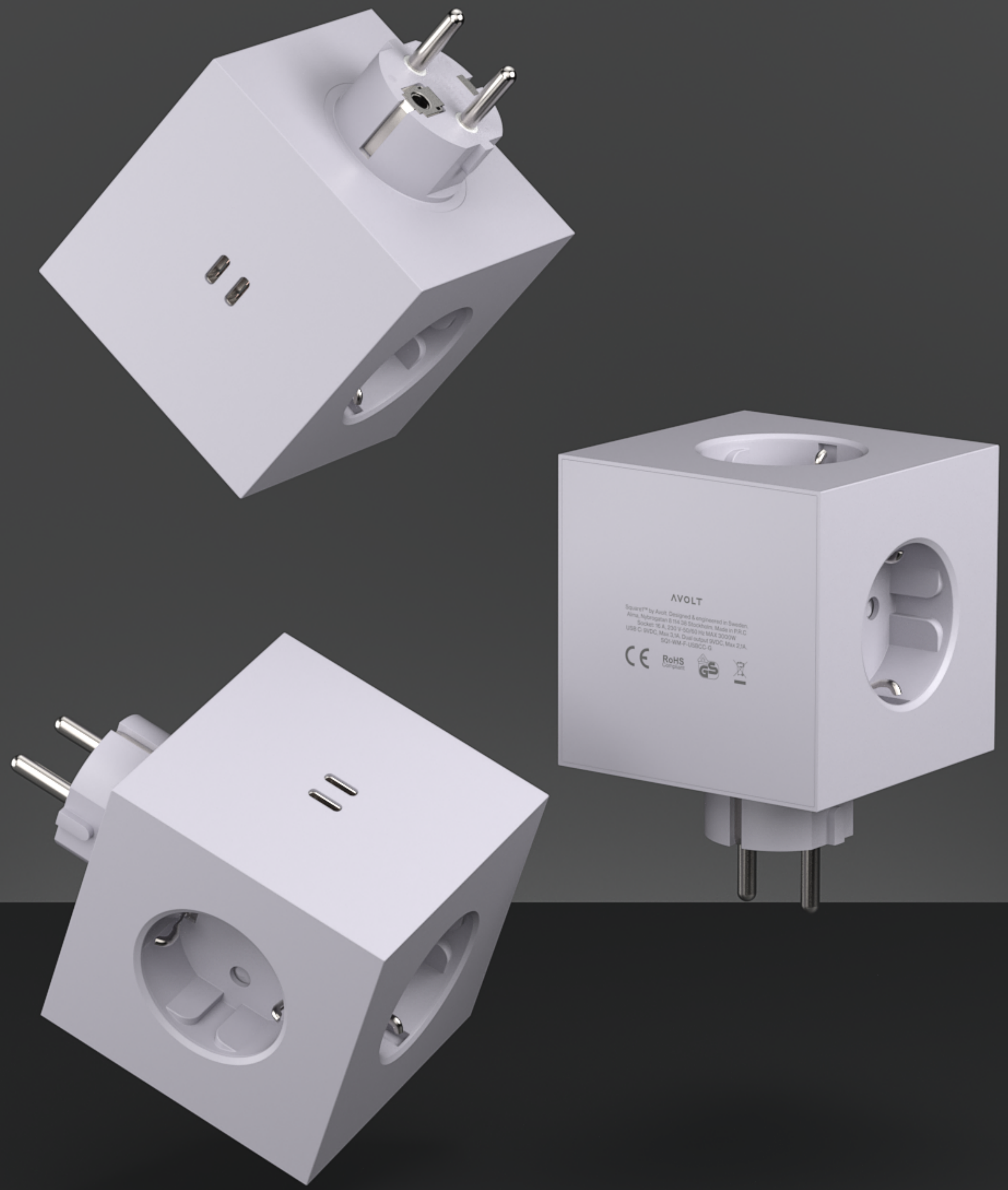





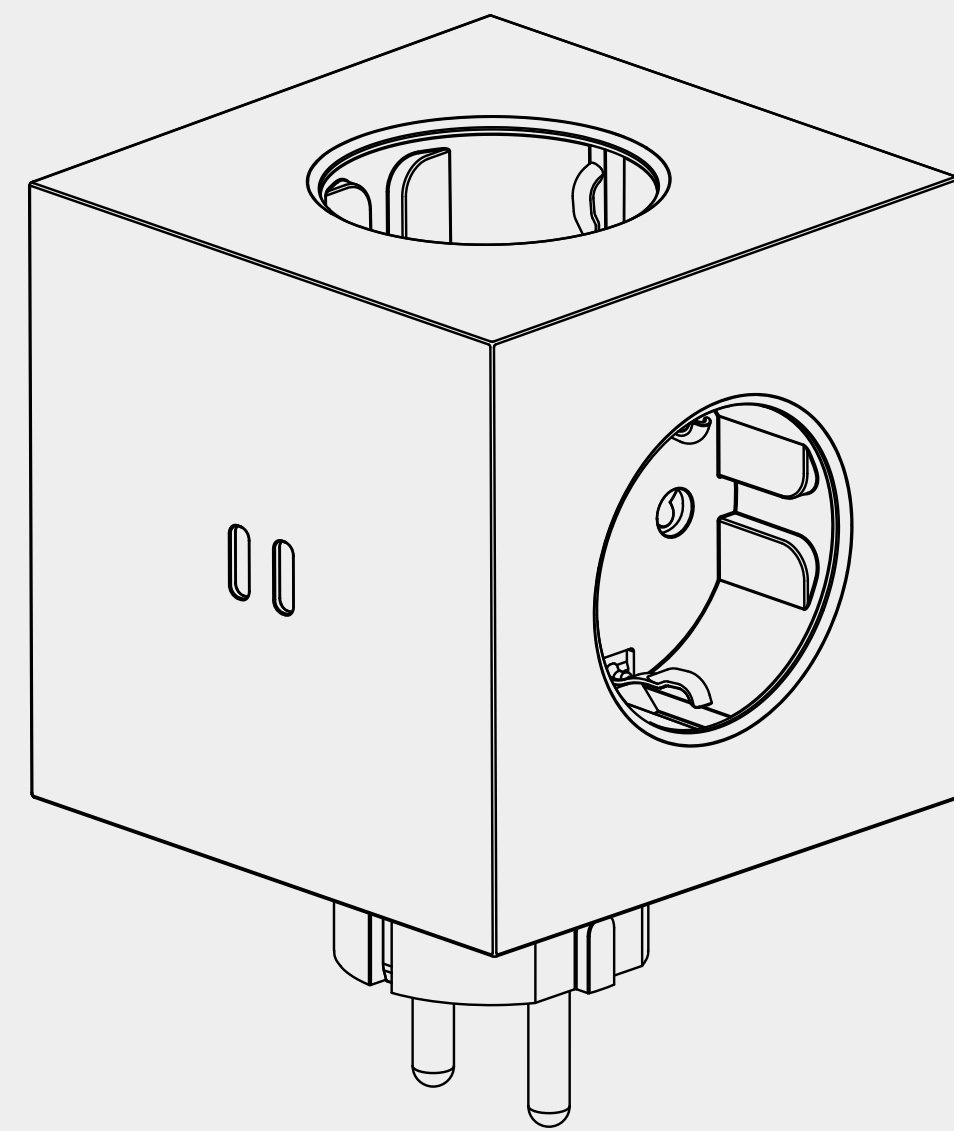

Sqaure 2 - Wall mount in Apple White

## Square 2



# Specifications



|  |  |   |
|--|--|---|
|  | Model:<br><p style="text-align: center;"><b>Square 2</b></p> | By:<br><p style="text-align: center;"><b>AVOLT</b></p>  |
|  | Designed and engineered in Sweden.<br>Assembled in P.R.C.    | Designers:<br>J. Runströmer<br>V. Lundberg  |
|  | Product name:  | Sqaure 2 USB C  |
|  | Material:  | Plastic (+20% recycled materials)   |
|  | Plug type:   | F-type schuko   |
|  | Dimensions:  | 7.6cm x 7.6cm x 11.5cm  |
|  | Socket:  | 3x Type F - 16A, 100-240V - 50/60 HZ, MAX 3680W   |
|  | USB:   | 2x USB Type C, Dual Output - 5/9/15VDC, Max 2.1 A each<br>Single Output - 5/9/15VDC, Max 3,1 A  |
|  | Product weight:  | 300g  |
|  | Features:  | This product's materials have excellent electrical and thermal insulation characteristics. The sockets are childproof and has protective shutter. The cube can swivel around the plug.  |
|  | Color Options:   | Stockholm Black, Gotland Gray, Old Pink   |
|  | Certifications:  |      |



USB A - Lightning (Apple)







**Cable 1**

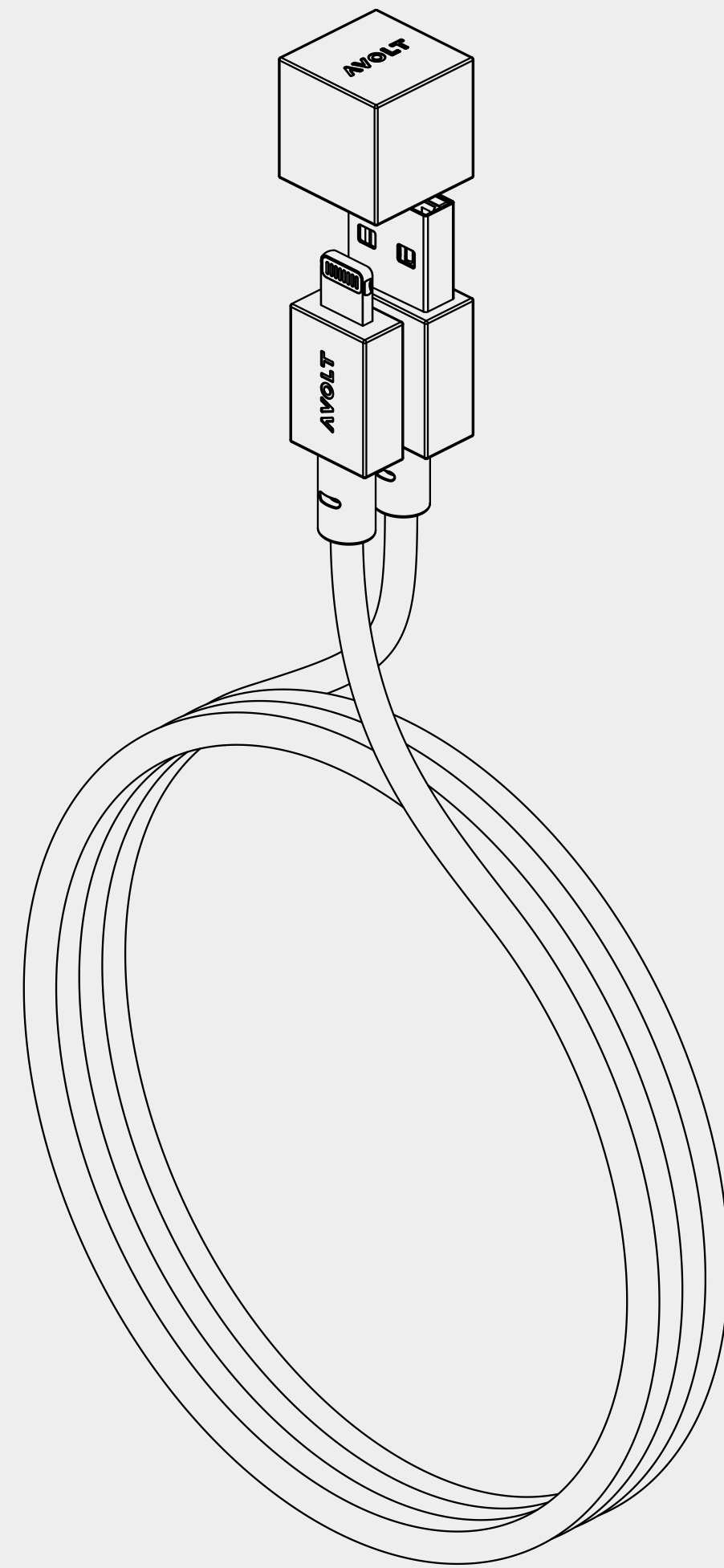

# Specifications



|                      |   |            |                                   |
|----------------------|---|------------|-----------------------------------|
| Model:               | <b>Cable 1</b>  | By:        | <b>AVOLT</b>                      |
|                      | Designed and engineered in Sweden.<br>Assembled in P.R.C.   | Designers: | J. Runströmer<br>Tony S Kureekkal |
| Product name:        | Cable 1 USB A to Lightning  |            |                                   |
| Material:            | TPE (+80% recycled materials)   |            |                                   |
| Cable length / plug: | 1.7m (rubber finish)  |            |                                   |
| Dimensions:          | 173cm x 1.5cm x 1.5cm, 3.4mm cable diameter   |            |                                   |
| Socket:              | USB Type A, Apple Lightning ( C89 chip)   |            |                                   |
| USB:                 | Max Output - 5/9VDC, Max 2.4 A  |            |                                   |
| Product weight:      | 70g   |            |                                   |
| Features:            | The cable and housing are made of 100% recycled TPE. Cable 1 is MFi certified and seamlessly compatible with all Apple lightning enabled devices. The included cap helps keep the cable organised.  |            |                                   |
| Color Options:       | Stockholm Black, Gotland Gray, Old Pink   |            |                                   |
| Certifications:      |      |            |                                   |



**AVOLT**

**Empower people    Extend power    Always in style**